



# Operating Instructions for washing machine W 820

---

It is essential to read these operating instructions before installing or using the machine to avoid the risk of accident, or damage to the machine.



M.-Nr. 04580320

# Contents

---

	Page
Guide to the machine . . . . .	3
Caring for the environment . . . . .	5
Before using for the first time . . . . .	6
Warning and Safety Instructions . . . . .	7
Preparing the wash load . . . . .	9
Wash care symbols . . . . .	10
Adding detergent . . . . .	11
Adding fabric conditioner/starch . . . . .	12
Programme selection . . . . .	13
Changing a programme sequence . . . . .	14
Programmes . . . . .	15
Programmable functions . . . . .	18
After washing . . . . .	21
Cleaning and care . . . . .	22
Problem solving guide . . . . .	26
After sales service . . . . .	30
Installation . . . . .	31
Electrical connection . . . . .	34
Plumbing . . . . .	36
Technical data . . . . .	38

## **Help to protect our environment**

### **Disposal of the packing material**

The transport and protective packing is mostly manufactured from the following re-useable materials:

- Corrugated paper / card
- Polystyrene - CFC free
- Polyethylene foil (transparent)
- Fibre board - solvent free
- Wood - untreated
- Packaging straps: Polyamide (blue)  
Polypropylene (black)

Rather than just throwing these materials away, please take them to the nearest local authority collection point for specific waste.

### **Disposal of your old machine**

Old machines contain materials which can be recycled. Please contact your local authorities or scrap merchant about potential recycling schemes, before disposing of the appliance.

# Guide to the machine

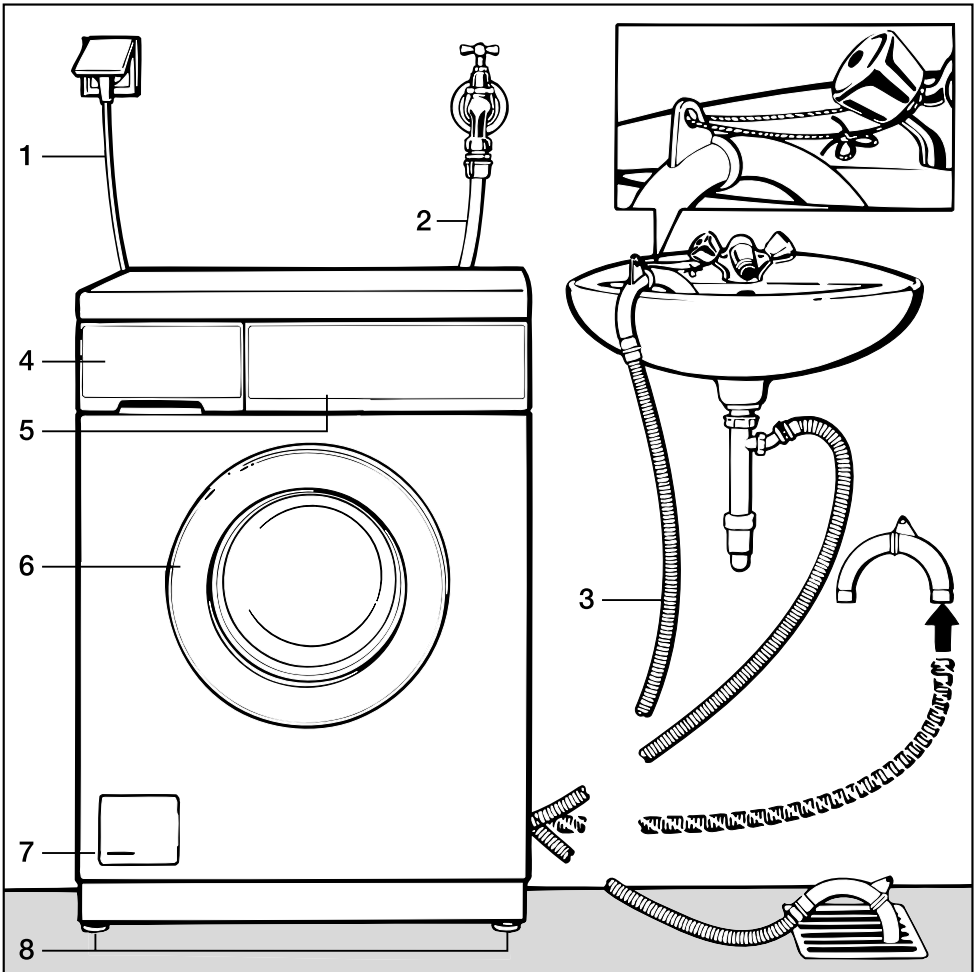

**1** Supply cable

**2** Inlet hose (able to withstand pressures up to 70 bar)

**3** Flexible drain hose, with detachable swivel elbow

**4** Detergent dispenser drawer

**5** Facia panel with controls

**6** Drum door

**7** Access panel - drain pump and filter, emergency door opener

**8** Four height adjustable feet

# Guide to the machine

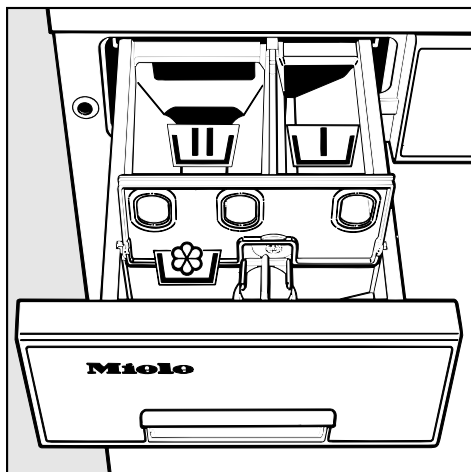

## Detergent dispenser drawer

Compartment  - for the pre-wash

Compartment  - for the main wash

Compartment  (with extra lid) - for fabric conditioner or liquid starch formulation

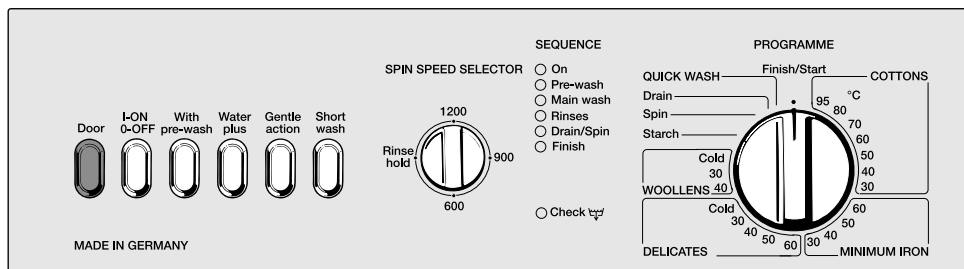

Button "Door"  
opens the drum door

Button "On/Off"  
to switch on or off or  
interrupt a programme  
Light "On" illuminates

Pushbutton switches for additional func-  
tions

Spin speed selector

Programme sequence indicator  
(LED indicator lights)

Programme selector switch

## **Caring for the environment**

Caring for the environment means saving water, energy and detergent when washing. This machine is equipped with the Hydromatic System and the Ball Valve for economical use of resources. These systems offer a variety of technical innovations e.g. the drum ribs, which are designed to enable economical washing without compromising on results.

The automatic load control facility enables loads of between 1 and 5 kg to be washed using only as much water and electricity as is required for an effective wash.

Spinning at the high speed of 1200 rpm reduces drying times and energy consumption if laundry is dried in a tumble dryer after washing.

## **Economy tips**

To help you wash most economically, remember the following tips:

- Always wash with the maximum laundry load specified for each programme. This uses the energy to the best advantage.
- Only use the correct amount of detergent required for the water hardness level in your area, as recommended by the manufacturer.
- If laundry is not heavily stained, select a lower temperature setting than indicated on the laundry care label (but when using a lower temperature do not select the “short”-option).
- Lightly soiled laundry can be washed using a “short”-programme (additional temperature reduction not recommended).

# Before using for the first time

## Important:

the appliance must be properly installed and connected to the water and electricity supply according to local and national regulations.

For further information read the instructions on pages 31 - 37

Check that the transit fitting at the rear has been removed.

## Before using for the first time prime the ball valve as follows:

- Switch on the machine.
- Turn the selector switch to “Starch”.
- Once the drum starts turning: set the programme selector to “Drain”.
- When the water has drained: turn the programme selector to the “Finish/Start” position.
- Switch the machine off.

The ball valve is operational.

## Any residual lubricants and water from testing still in the machine should be flushed out as follows:

- Do not load any laundry in the machine.
- Add a little detergent to compartment **II**.
- Switch on the machine.
- Turn the programme selector switch to the “Cottons 60°C” programme.
- Press the “Short” button.
- The residues will have been flushed out once the programme has finished.

## Water hardness reminder.

The amount of detergent will depend on various factors including the water hardness level in your area. Set the water hardness dial located in the detergent dispenser box as a reminder.

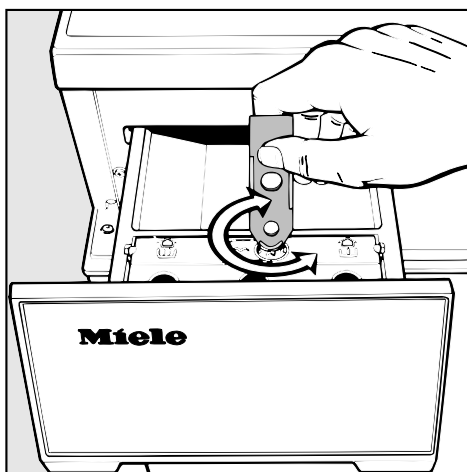

- Turn the dial to the required setting. Use the spatula supplied with the machine. It is located at the rear of the dispenser drawer facia (see page 23).

If you do not know how hard the water is in your catchment area, please contact your local water authority.

## Water hardness

Hardness range	water	mg/litre	Clake's scale	°dH (German)
1	soft	up to 135	up to 10°	0-7°
2	medium	up to 250	10°-20°	7°-14°
3	hard	up to 380	20°-25°	14°-21°
4	very hard	over 380	over 25°	over 21°

# Warning and Safety Instructions

---

This appliance is designed and intended only for normal household use in the U.K. It should never be operated by children. Supervise its use by the elderly or infirm.

Read the operating instructions through before using this machine for the first time, as this is for your safety and the protection of the machine. They give notes on the safety, the use and the maintenance of the machine.

Further warning and safety instructions are given in the text as appropriate.

## **...before using for the first time**

■ Do not install your washing machine in rooms where sub-zero temperatures may occur. Frozen hoses may burst under pressure.

The reliability of the electronic control system may be impaired at temperatures below freezing point.

■ Before using the machine for the first time, check that the transit fitting at the rear of the machine has been removed (see page 31). During spinning, a transit fitting which is still in position may result in damage to both the machine and adjacent furniture or appliances.

■ If the drain hose is attached to a wash basin or sink, make sure it is secure, (see illustration in the section "Guide to the machine"), so that the force of the water flowing out of the hose does not dislodge it, as this will otherwise result in flooding. If hooking the hose into a wash basin, check that the water can drain off

quickly enough to prevent the sink from overflowing.

■ Keep these operating instructions in a safe place.

## **...when using your machine**

■ Only wash items which are declared by the manufacturer to be machine-washable on the care label (textile care G.B. laundry care, AUS), (see Care labels on page 10).

■ Descaling agents contain acid. Only use proprietary non-corrosive descaling agents and strictly observe the manufacturer's instructions. After descaling, always run several full rinse cycles to remove any acid residue and to protect component parts from corrosion.

■ Never use detergents containing solvents in this machine, as this may result in damage to component parts and create toxic fumes. Such detergents also pose a fire and explosion hazard.

■ Textiles which have been pre-treated in detergents containing solvents must be thoroughly rinsed in clean water before being washed in this machine.

■ Do not use dye removers as these contain sulphur compounds which may damage washing machines.

# Warning and Safety Instructions

---

■ Dyes must be specified as suitable for use in washing machines. Always observe the manufacturer's instructions.

■ If washing at very high temperatures remember that the porthole glass will be hot. Do not let children touch it during a wash programme.

■ The machine should only be operated unsupervised if there is a floor drain in the immediate vicinity.

■ The best materials are used in the manufacture of this machine, and every care is taken to check all parts. However, with time, deterioration of parts can occur, especially with such components as hoses, giving rise to leaks. This should be borne in mind if operating the machine without supervision. Check the hose regularly for signs of wear, and change in good time, to avoid leaks and subsequent damage.

■ Always make sure the drum is stationary before reaching in to remove washing. Reaching into a moving drum is extremely dangerous.

■ Foreign objects (e.g. nails, coins, paper clips etc.) can cause damage to textiles and components in the machine. Take care to empty all pockets etc. so that these do not go into the machine.

## **...in the event of faults**

■ Electrical appliances should only be repaired by suitably competent personnel. Incorrectly repaired machines may pose a considerable risk to the user.

■ Disconnect the machine from the mains power supply by switching off at the wall socket, unplugging, or withdrawing the mains fuse.



# Preparing the wash load

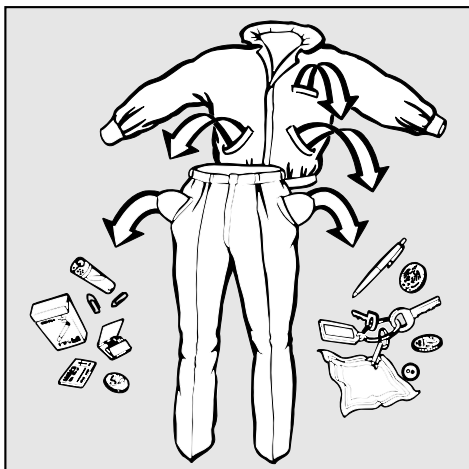

- Empty all pockets.

Foreign objects (e.g. nails, coins, paper clips etc.) can cause damage to textiles and components in the machine.

## Sort the laundry

Most garments have a textile care label in the collar or side seam. Sort the laundry by care label symbols.

Only wash items in this machine which are declared by the manufacturer as being machine washable on the textile care label.

Dark textiles often contain “excess dye,” and should be washed separately several times before being included in a mixed load.

Delicate textiles should be washed separately in a delicates programme.

Only wash textiles made from wool or wool mixtures if they are declared as being suitable for machine washing on the textile care label.

## Pre-treating the washing

Badly soiled areas, e.g. collars and cuffs, and water soluble stains, can be pre-treated with bar soap, liquid detergent or detergent mixed into a solution or paste.

With particularly stubborn stains ask your Dry Cleaner for advice.

Do not use detergents containing solvents in this machine.

## Loading the drum

Unfold laundry and load loosely in the drum. To achieve best results it is advisable to make up mixed loads consisting of both large and small items. This improves the washing effect and helps distribute the load evenly to keep the machine stable and reduce the noise level during spinning.

It is advisable to weigh the load first to make best use of the machine’s capacity.

## Maximum load weights are noted below:

COTTONS . . . . .	5.0 kg
MINIMUM IRON . . . . .	2.5 kg
DELICATES/SYNTHETICS . . . . .	1.0 kg
WOOL . . . . .	1.0 kg
QUICK WASH . . . . .	2.5 kg

With curtains: Remove lead weights and strips or place in a laundry bag. Woollens and knitted garments should be turned inside out if the manufacturer recommends it.

## Close the drum door

Make sure that there is no obstruction between the drum door and seal.

# Textile care symbols

## Washing



Cottons

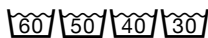

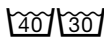

Minimum iron



Delicates, Wool

The significance of the bar beneath the wash tub:

no bar      normal (maximum) agitation  
      eg Cottons programme

bar      reduced (medium) agitation,  
      eg Minimum iron programme  
 + Gentle action, or Delicates programme.

broken bar      much reduced (minimum)  
      agitation, Woollens programme

Machine washable woollens

Use the special “Wool” programme, and only wash woollens bearing the label shown here:



This symbol is registered by the IWS (International Wool Secretariat).



Hand wash



do not wash



dry clean



do not dry clean



suitable for chlorine bleaching



not suitable for chlorine bleaching

## Tumble dry



at normal temperature



at the lower temperature



do not tumble dry

## Ironing



hot iron



medium hot iron



cool iron



do not iron

N.B. If you have any textiles with the older wash care labels, select a programme according to the table below.

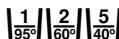

Cottons

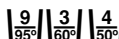

Minimum iron



Delicates



Woollens

All modern detergents produced for automatic washing machines are suitable, including liquid, compact (concentrated) and special application detergents. Use dispensing aids e.g. balls if these are supplied with the detergent. Woollens and knitware containing wool mixtures should be washed using a detergent specifically designed for washing woollens.

Add the right amount of detergent as recommended on the packaging. The amount dispensed will depend on the following:

- the quantity of laundry
- the water hardness level
- the level of soiling

## **It is important to dispense the correct amount, because...**

**...too little detergent results in the following:**

- The laundry will not get properly clean and will in time become grey and hard to the touch.
- Greasy particles cling to the laundry.
- Lime deposits on the heater elements.

**...too much detergent results in the following:**

- Excessive foam.
- Low level of agitation.
- Poor washing and rinsing results.

Water is taken in through compartment **III** in the main wash. If the capacity of compartment **III** is insufficient for the amount of detergent needed where water hardness is above 380 mg/l (in hardness area 4), the Customer Service Engineer can adjust the machine so that water can also be taken in through compartment **I** to take detergent into the main wash.

## **Water Softeners**

A water softener can be used to cut down on the use of detergents in water hardness ranges 2 - 4. Dispense according to the amount specified on the packaging. First add detergent and then the water softener. Detergent can be dosed as for water hardness range 1.

We recommend: if you wash using several components (e.g. special application detergents), dispense the agents in the following order into compartment **III** :

1. Detergent
2. Water softener
3. Stain salts

This way the agents are distributed better.

# Fabric conditioners / starch formulations

Fabric conditioners make garments soft and fluffy to handle and help prevent static cling when tumble drying. Dispense according to the manufacturer's recommendations.

- Open the lid of compartment .
- Add fabric conditioner, but do not exceed the max. level.

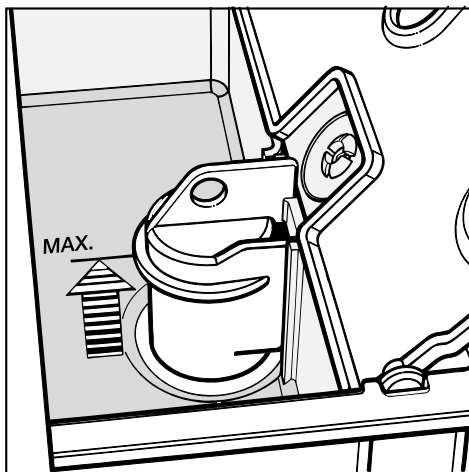

- Close the compartment lid and push in the dispenser drawer.

The conditioner is automatically dispensed in the last rinse. At the end of the programme a small amount of water remains in the fabric conditioner compartment.

## Texturiser and liquid starch formulations

These synthetic starch formulations give body to items e.g. shirts, tablecloths and bed linen. Add starch formulations to the fabric conditioner compartment following the same procedure as for fabric conditioner.

## Powder starch

- Prepare and dispense the starch solution in accordance with the manufacturer's instructions.
- Add to compartment .
- Turn the programme selector switch to the "Starch" position.

If preferred select "rinse hold" to prevent creasing. The laundry remains suspended in the last rinse water.

To continue the programme:

- Select "Drain" or "Spin".

The following basic programmes are available:

## **Cottons**

- Low water level for washing and rinsing; 4 rinses; final spin max. 1200 rpm.

## **Minimum iron**

- Low water level for washing, medium water level for rinsing; 3 rinses; final spin max. 900 rpm.

## **Delicates**

- High water level for washing and rinsing; 3 rinses; final spin max. 600 rpm.

## **Woollens**

- Medium water level for washing, higher water level for rinsing; 3 rinses; final spin max. 900 rpm. Reduced drum movement.

By selecting one or more of the push-button functions basic programmes can be tailored to the type of laundry being washed.

## **“With pre-wash”**

- for heavily soiled and stained laundry items.

## **“Water plus”**

- This is recommended if the water level with the “Gentle action” option is not sufficient for particularly delicate fabrics,
- if more water is required for dispensing the detergent,

- for washing and rinsing cottons and minimum iron items,
- for washing delicate items.

## **“Gentle action”**

- For gentle washing of slightly soiled laundry items, e.g. delicate fabrics which tend to pill (i.e. form knobbles). Drum movement is reduced by half.

## **“Short”**

- For lightly soiled laundry items. The length of the main wash is shortened. An additional reduction in temperature is not recommended as this may lead to poorer washing results.

## **Selecting the spin speed**

- Set the selector switch to the highest appropriate setting to save energy if laundry is to be dried in the tumble drier. The spin speed in the “Minimum iron” and “Woollens” programmes is automatically limited to 900 rpm, and in the “Delicates” programme to 600 rpm.

## **“Rinse hold setting”**

- Laundry remains suspended in water at the end of the programme. If the washing is to be spun, turn the spin speed selector from “Rinse hold” to the appropriate spin speed, or turn the programme selector switch to “Drain”.

# Changing the programme sequence

---

## Selecting a programme

The programme can only be started when:

- The machine is switched on.
- The drum door is properly shut.
- The programme selector switch is at the “Finish/Start” position.

Turn the programme selector switch to the required programme.

## To cancel a programme:

- Turn the programme selector switch to the “Finish/Start” position.

## To interrupt a programme:

- Switch the machine off. To re-start a programme switch the machine on again.

## To change an incorrectly selected programme:

- Turn the programme selector switch to “Finish/Start”. When only the “On” LED is illuminated a new programme can be selected.

To change a programme where the child safety option had been set see page 18.

During a programme it is possible to

- omit one or more programme stages
- or
- repeat one or more programme stages.

## To omit a programme stage:

a programme stage must first be reached before it can be omitted:

- Turn the programme selector to “Finish/Start”.

As soon as the programme sequence lamp for the stage at which the programme should continue starts flashing:

- turn the programme selector switch to the appropriate programme within 3 seconds.

## To repeat a programme stage:

a programme stage must have finished before it can be repeated:

- Turn the programme selector switch to “Finish/Start”.

When only the “On” LED is illuminated:

- a new programme can be selected.
- After approx. 5 seconds, turn the programme selector switch back to “Finish/Start”.

Once the indicator light of the programme stage to be repeated starts flashing:

- turn the programme selector switch to the appropriate programme within a period of 3 seconds.

# Programmes

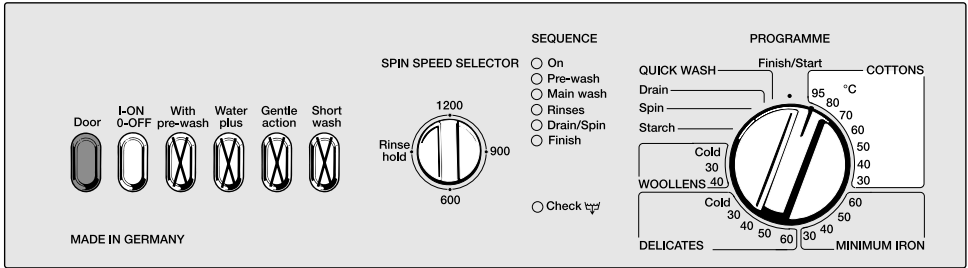

## Cottons

**X** = additional options

For cotton and linen textiles.

Max. 5 kg

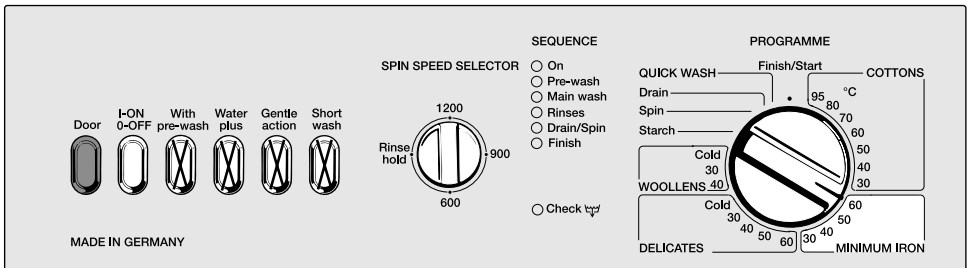

## Minimum iron

**X** = additional options

Minimum iron textiles in synthetic, mixed fibres or minimum iron cottons.

Max. 2.5 kg

# Programmes

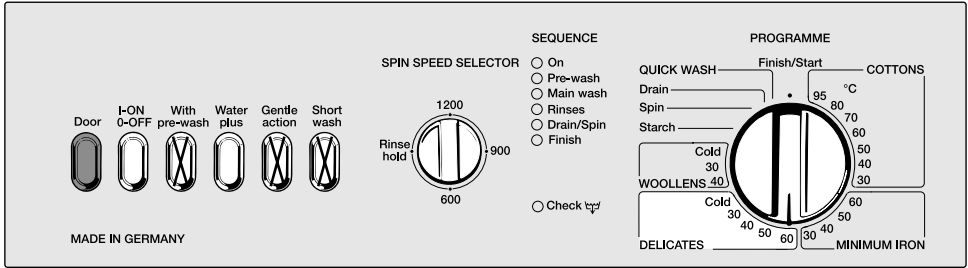

## Delicates

For delicate textiles in synthetic, mixed fibres and delicate cottons, acrylics, acetate and triacetate

Max. 1 kg

Machine washable curtains (see washing instructions): load loosely in the drum filling no more than 1/3 full.

Set the temperature according to the manufacturer's instructions.

**X** = additional options

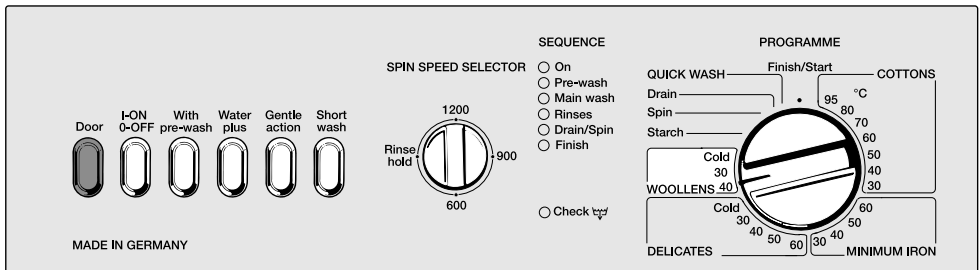

## Woollens

For woollen or wool mix textiles which have the woollens symbols shown under "Textile care symbols" stating that they are "machine washable".

Max. 1 kg



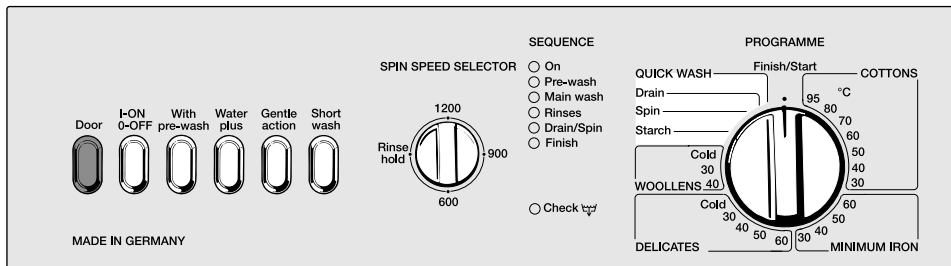

## Starching

For freshly washed textiles such as tablecloths, napkins, uniform garments etc.

Max. 5 kg

## Spin

For spinning garments such as those previously hand washed. These must be suitable for spinning in a machine.

## Drain

For laundry which is to be taken out of the machine wet for drip drying.

## Quick wash programme 40°C for cottons

For new garments which need to be washed before wearing for the first time. For freshening up clothes which have been in storage for a while.

Max. 2.5 kg

# Programmable functions

---

Additional programme functions can be selected if required:

## **High water level (only in Cottons rinses)**

Where rinse results are particularly important.

## **5th Rinse for Cottons programme**

For soft water areas (hardness range 1, up to 135 mg/l).

In soft water areas a higher water level can be selected in addition to a 5th rinse if rinse results are not as good as required.

## **Child-safety feature**

The washing machine ignores any changes after the first three minutes of starting the programme, i.e. if the programme selector switch is set to a different setting or an additional programme is selected.

The "On" lamp flashes.

Once the programme selector switch is turned back to its original position the "On" lamp stops flashing.

## **To change a programme:**

- Turn the programme selector switch to "Finish/Start".

The programme sequence indicator lamps start flashing in succession after about 30 seconds. You can select a different programme as soon as only the "On" light is lit up.

The three functions described above can be programmed by the Customer in four steps as shown on pages 19-20.

There are however other functions programmable after Step 2 which are reserved for Miele Service Engineers. They are not for Customer use, and are not activated as standard.

# Programmable functions

## To programme an extra Function:

First switch off the machine, close the door, and release all switches and set the programme selector switch to “Finish/Start”.

Carry out steps 1 and 2 within 4 seconds.

### Step 1:

- Press in the “On-Off” button

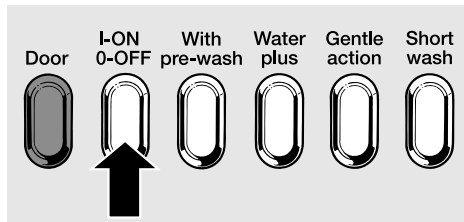

### Step 2:

- Press the “Water plus” button 4 times (i.e. press in and out twice)

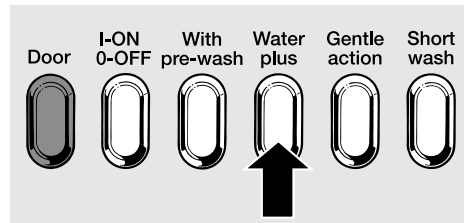

The “On” LED will now light up and the “Pre-wash” and “Main-wash” lights flash.

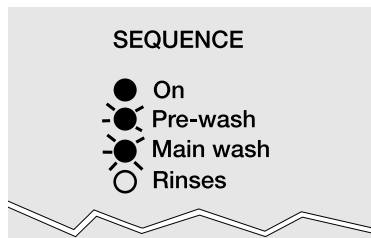

# Programmable functions

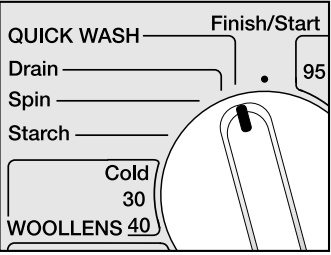
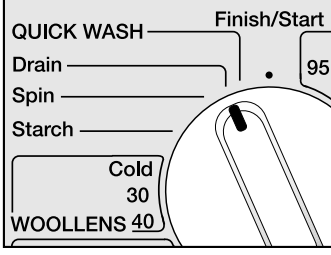
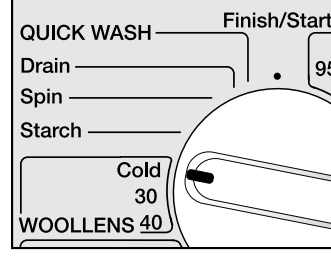
<p>Step 3:</p> <ul style="list-style-type: none"> <li>■ Set the Programme selector to: "Quickwash"</li> </ul>	 <p>programmablefunction: <b>High water level</b></p>
<p>or</p> <p>"Drain"</p>	 <p>programmablefunction: <b>5th rinse</b></p>
<p>or</p> <p>"Woolens cold"</p>	 <p>programmablefunction: <b>Child - safety</b></p>
<p>Step 4:</p>	<ul style="list-style-type: none"> <li>■ Press the "Water plus" button twice, (i.e. in and out once).</li> </ul>
<p>Then:</p>	<p>"Rinses/Rinse hold" LED lights up</p>
<p>Step 5:</p>	<ul style="list-style-type: none"> <li>■ To store the function: press the "On-Off" button.</li> </ul>

## Deleting the programmable function:

Follow the same instructions as given under “switching on the programmable functions”, step 1 to step 4 inclusive.

The “Rinses/Rinse hold” lamp goes out.

- Press “On/Off”.

The programmable function is deleted.

If after Step 2 you accidentally turn the selector switch to a setting other than one of the three in the chart above:

- Rinses/Rinse hold indicator does not light up - no function is activated
- Rinses/Rinse hold indicator lights up - proceed as for “Deleting the programmable function”.

Exception: the Rinses/Rinse hold indicator lights up if the switch was set to “Cottons 95°C”.

## After washing:

- Turn the programme selector switch to “Finish/Start”.
- Open the door.
- Switch the machine off.

Only remove laundry from the machine once the drum has stopped turning, otherwise you may seriously injure yourself.

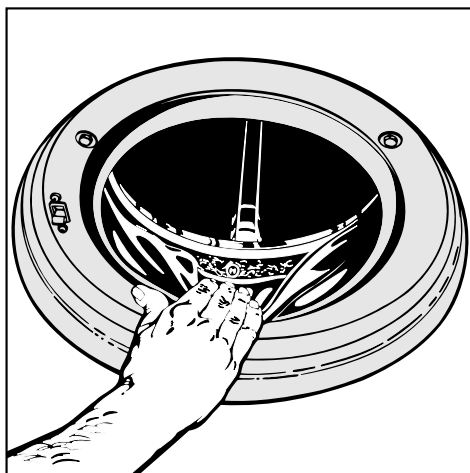

- Check the folds in the door seal for any small articles such as buttons or other foreign bodies which might be lodged there.
- Turn off the stopcock.
- Close the drum door.

Make sure the drum is empty, otherwise, when the machine is next used items may become damaged (e.g. shrink) or cause other laundry to discolour.

## Cleaning the washing machine

- Clean the casing with a mild non-abrasive detergent or soap and water.
- Wipe dry with a soft cloth.
- Clean the fascia panel with a damp cloth and dry with a soft cloth.
- The drum can be cleaned using a proprietary stainless steel cleaner according to the manufacturer's instructions.

Do not use abrasive cleaners or solvents.

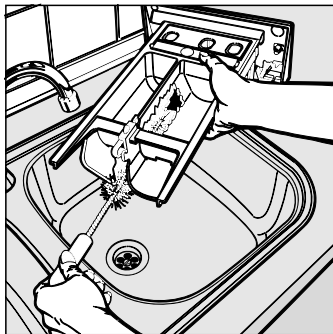

- Clean the dispenser compartments and the fabric conditioner duct.

## Cleaning the detergent drawer

- Pull out the drawer until a resistance is felt.

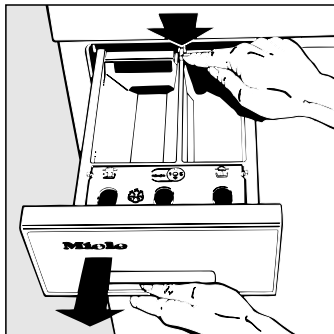

- Press down the red release knob and at the same time pull the drawer right out of the machine.

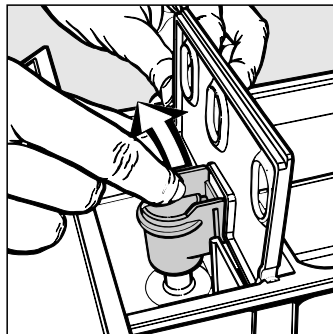

- Remove the siphon tube from compartment  and wash in warm water.

## To programme an extra Function:

First switch off the machine, close the door, and release all switches and set the programme selector switch to "Finish/Start".

Carry out steps 1 and 2 within 4 seconds.

Step 1:

- Press in the "On-Off" button

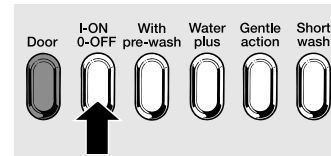

Step 2:

- Press the "Water plus" button 4 times (i.e. press in and out twice)

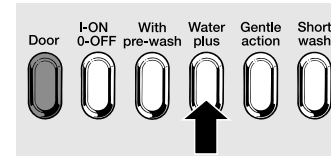

The "On" LED will now light up and the "Pre-wash" and "Main-wash" lights flash.

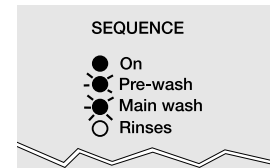

## Cleaning the drain pump and fluff filter

Check the fluff filter initially after 3 - 4 washes to ascertain how often it is likely to require cleaning.

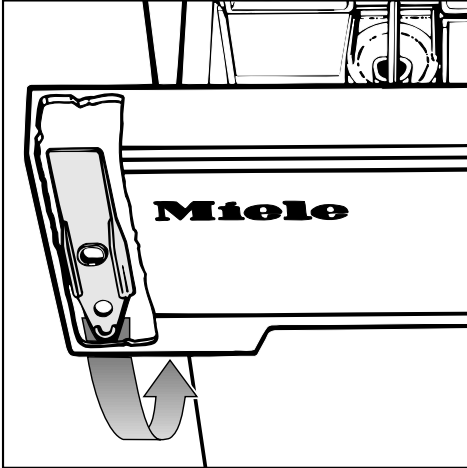

Take the flap opener from behind the detergent dispenser drawer.

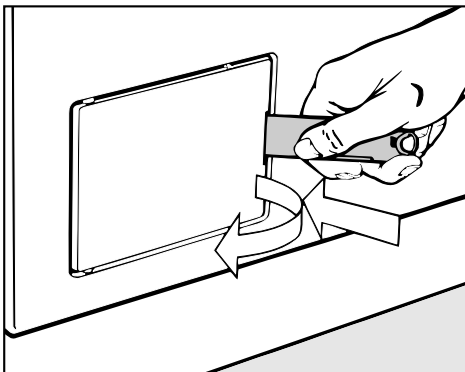

- Open the fluff filter flap.

- Place a 2 litre capacity dish underneath the drain fixture.

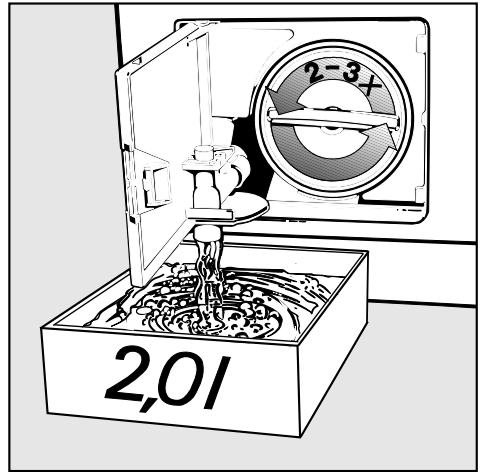

- Turn the fluff filter lid round 2-3 times. Do **not** take it right out. Approx. 2 litres of water will drain out of the hose.

If the drain outlet is clogged, more water will be retained in the machine, (max. 25l). In this case, screw the fluff filter back into position and empty the dish before repeating the procedure as often as necessary.

**Caution:** if laundry has been washed at a high temperature, water draining out of the machine will still be hot!

- Once the flow of water ceases, remove the fluff filter completely and clean it.

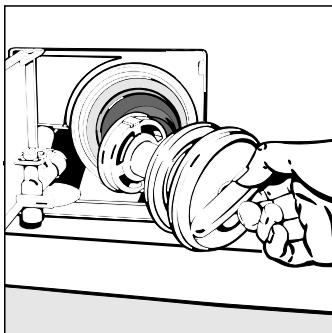

- Remove any foreign bodies (e.g. buttons, coins, etc.) and fluff.
- Turn the impeller by hand to check that it is free to rotate. Any foreign objects causing an obstruction should be removed.

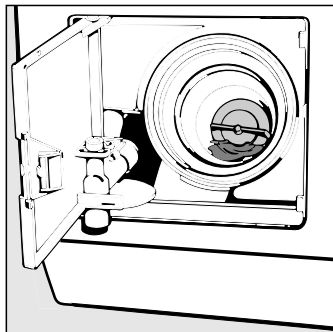

- Clean inside the fluff filter housing. Remove any deposits of lime scale and detergent or foreign bodies from the thread of the filter housing and filter unit. Because water has been drained off the ball valve function has to be re-stored (see page 6).

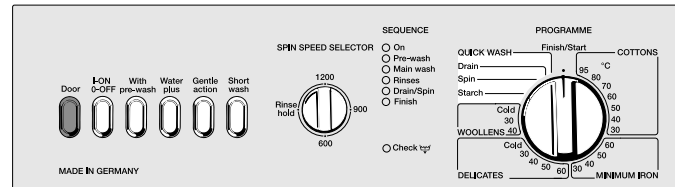

### Starching

For freshly washed textiles such as tablecloths, napkins, uniform garments etc.

Max. 5 kg

### Spin

For spinning garments such as those previously hand washed. These must be suitable for spinning in a machine.

### Drain

For laundry which is to be taken out of the machine wet for drip drying.

### Quick wash programme 40°C for cottons

For new garments which need to be washed before wearing for the first time. For freshening up clothes which have been in storage for a while.

Max. 2.5 kg



# Cleaning and Care

The washing machine has two inlet filters to protect the inlet valve:

## To clean the filter in the inlet hose:

- Close the stopcock.
- Carefully unscrew the knurled coupling connecting the inlet hose to the stopcock anti-clockwise, using pliers if necessary.
- Remove the rubber seal from the recess.

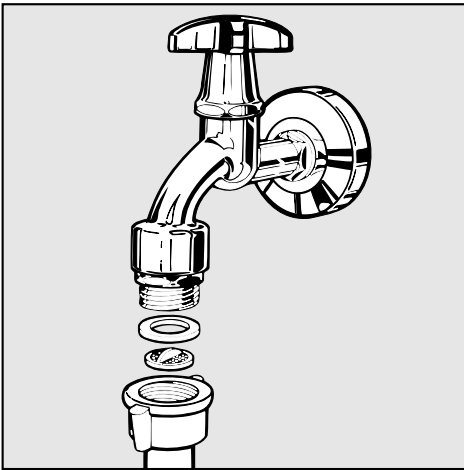

- Using pointed pliers, take hold of the plastic filter bar and remove the filter. Clean under running water and carefully remove any grit particles.
- Put the filter and seal back in the reverse order and reconnect the hose. Turn on the stopcock and check the connection is watertight.

Inspect the inlet hose which is subjected to high pressure while the machine is in operation. The hose should be replaced if there are small cracks in

the surface, or if it has been otherwise damaged.

If replacing the inlet hose only use a hose able to withstand pressure up to 70 bar. Miele's own hoses meet this requirement.

## To clean the filter in the water inlet valve:

- Using pliers, carefully loosen the ribbed plastic nut on the inlet valve, and unscrew.

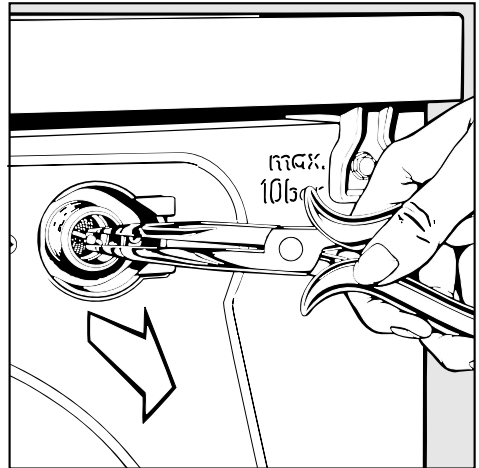

- Use water pump pliers to withdraw the plastic filter by the bar (see illustration). Clean and put back.

The two filters - one in the pressure hose union and one in the inlet connection to the solenoid valve - must not be removed.

Any work on the electrical components of this appliance should only be carried out by a suitably qualified and competent person in accordance with local and national regulations. Unauthorised repairs could be dangerous.

## Check warning lamp flashes

Drainage fault

- Check whether the fluff filter is clogged. Clean the filter and pump as described on page 23 if necessary.
- Check whether the drain hose is kinked or trapped.

The check lamp goes out when the programme selector switch is turned to the "Finish/Start" position.

## The "Finish" indicator lamp is on, but the laundry in the machine has not been washed.

The water inlet is not open:

- Turn the programme selector to "Finish/Start".
- Turn on the water supply at the stopcock.
- Select a programme.

The water inlet system is blocked:

- The stopcock has not been fully opened.
- The inlet hose is kinked or trapped.
- The water pressure is too low

Check if the water flow through the stopcock is 5 litres in 15 seconds.

- The filters in the inlet hose are clogged (see "Cleaning and Care" on page 25).

If little or no water is taken in during the next programme, the water pressure may be too low. If it is adequate there may be a technical fault. In this case, call your local service dealer or the Miele Service Department.

There are, however, minor faults which can be corrected without contacting the Service Department.

## A selected programme does not begin

The "On" indicator lamp does not light up.

Check that

- the door is properly closed,
- the mains plug is plugged in and that the fuse or circuit breaker has not tripped.

The "On" indicator lamp is on, a programme has been selected, but the "Pre-wash" or "Main wash" indicator lights do not light up.

The programme selector switch was not turned to the "Finish/Start" position before the programme was selected. The following selection sequence is important:

1. Turn the programme selector switch to "Finish/Start".
2. Select a programme.

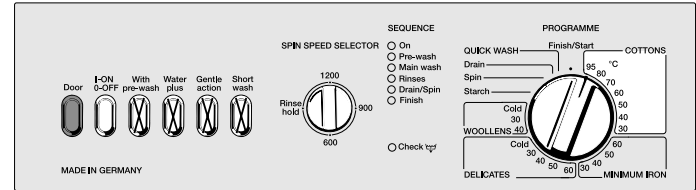

## Cottons

For cotton and linen textiles.

Max. 5 kg

**X** = additional options

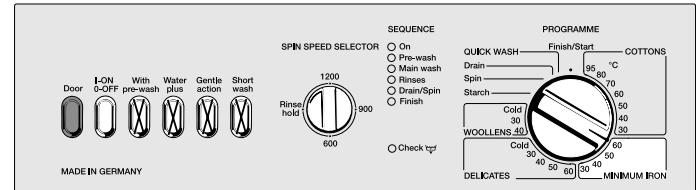

## Minimum iron

Minimum iron textiles in synthetic, mixed fibres or minimum iron cottons.

Max. 2.5 kg

**X** = additional options

## **Despite adequate water supply pressure, the machine takes a long time to fill.**

Clean the filters in the water inlet system as described on page 25.

## **Large amounts of unused detergent remain in the dispenser drawer.**

Water supply pressure is too low.

- Clean the filters as described on page 25.
- Select the “Water plus” function if necessary.

Washing powder becomes viscous when used together with a water softener.

- In future pour washing powder into the detergent dispenser before adding water softener.

## **Fabric conditioner is not completely dispensed or water remains in the compartment .**

The dispenser drawer was opened while fabric conditioner was being flushed in.

The siphon tube is either incorrectly positioned or clogged. Clean as described on page 22.

## **Excessive build-up of foam**

To avoid this problem from the outset, take note of the following points:

- Follow the manufacturer’s dosage recommendations on packaging carefully.
- Take the water hardness level into account.

- For lightly soiled articles or a small load, reduce the amount of detergent accordingly.
- Pre-soaked items should be rinsed thoroughly before washing.

## **The “Pre-wash” indicator lamp is flashing.**

- Start the programme again. If the indicator still flashes call the Service Department.

## **The “Main wash” indicator lamp flashes during, or after the end of a programme.**

If this occurs again with the next programme there is a technical fault. Call the Service Department.

## **Laundry is either not spun at all or not spun satisfactorily.**

- The selected spin speed was too low.
- The machine was not able to distribute the laundry load evenly. To protect the machine, laundry was either only spun at a reduced speed or not at all.
- Large items which tangle or roll up in the drum (e.g. bath mats) can cause an imbalance during the spin cycle. For safety reasons, the machine does not spin if this is the case. Attempts to build up spin speed are repeated, however, until the time allocated to spinning has expired. It is therefore important to make up mixed loads consisting of large and small items.
- The fluff filter may be clogged. Clean the filter and the pump as described on page 23-24.

### The machine shakes during the spin cycle.

The most likely cause is that the four machine feet are not resting securely on the floor. Level the machine as shown on page 33.

Weak floorboards not only lead to excessive noise but also to shaking during the spin cycle (see page 31 for advice).

### Lime deposits are visible on the surface of the drum.

- Use a descaling agent to remove the deposits. Consult the manufacturer's instructions before use to ensure that the product is suitable for use in washing machines.
- Take the water hardness level into account when dispensing detergent.

### Opening the drum door in the event of a power failure

- Switch off the washing machine.
- Open the drain panel and drain off any water as described on page 23 if there is water still in the drum.

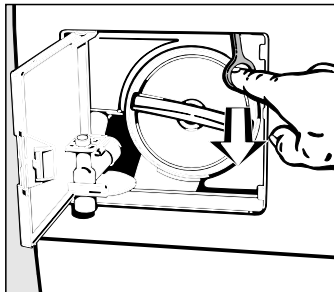

- Pull the ring of the door mechanism downwards, and the door will open.

Always make sure the drum is stationary before reaching in to remove washing. Reaching into a moving drum is extremely dangerous.

The following basic programmes are available:

### Cottons

- Low water level for washing and rinsing; 4 rinses; final spin max. 1200 rpm.

### Minimum iron

- Low water level for washing, medium water level for rinsing; 3 rinses; final spin max. 900 rpm.

### Delicates

- High water level for washing and rinsing; 3 rinses; final spin max. 600 rpm.

### Woolens

- Medium water level for washing, higher water level for rinsing; 3 rinses; final spin max. 900 rpm. Reduced drum movement.

By selecting one or more of the push-button functions basic programmes can be tailored to the type of laundry being washed.

### “With pre-wash”

- for heavily soiled and stained laundry items.

### “Water plus”

- This is recommended if the water level with the “Gentle action” option is not sufficient for particularly delicate fabrics,
- if more water is required for dispensing the detergent,

- for washing and rinsing cottons and minimum iron items,
- for washing delicate items.

### “Gentle action”

- For gentle washing of slightly soiled laundry items, e.g. delicate fabrics which tend to pill (i.e. form knobbles). Drum movement is reduced by half.

### “Short”

- For lightly soiled laundry items. The length of the main wash is shortened. An additional reduction in temperature is not recommended as this may lead to poorer washing results.

### Selecting the spin speed

- Set the selector switch to the highest appropriate setting to save energy if laundry is to be dried in the tumble drier. The spin speed in the “Minimum iron” and “Woolens” programmes is automatically limited to 900 rpm, and in the “Delicates” programme to 600 rpm.

### “Rinse hold setting”

- Laundry remains suspended in water at the end of the programme. If the washing is to be spun, turn the spin speed selector from “Rinse hold” to the appropriate spin speed, or turn the programme selector switch to “Drain”.

## **Grey greasy particles cling to washed laundry.**

The wash load was heavily soiled with greasy substances such as ointments or lotions, and the amount of detergent was insufficient to break down the particles of grease.

- In future, either add up to 50% more detergent to the main wash when washing loads of this nature or use liquid detergent in programmes up to 60°C.
- Before washing the next load, run a Cottons 60°C programme with liquid detergent without a load to clean the machine.

## **Brown stains appear on the laundry after washing.**

An excessively high manganese or iron content in the water supply can cause stains of this nature to appear on the laundry, in particular when low-phosphate detergent is used.

- Have the quality of the water supply checked and take remedial action if necessary.

## **After washing, knobbles (pilling) appear on the fabric**

In normal everyday wear of certain fabrics pilling may occur. The Gentle action function should be selected when washing these fabrics, or another programme with higher water levels and reduced agitation to lessen the risk of further pilling.

## **Laundry washed with liquid detergent is not cleaned.**

Liquid detergent does not contain any bleaching agents capable of removing stains, e.g. fruit, coffee and tea stains.

- To remove such stains, use a general-purpose washing powder which contains bleach or enzymes, or pre-treat laundry.
- pour stain remover according to manufacturer's instructions into compartment **III** of the detergent dispenser and dispense the liquid detergent directly using a proprietary dispensing aid.

Never pour stain remover and liquid detergent into the same compartment.

In the event of any faults which cannot be remedied, or if the appliance is under guarantee, please contact:

- Your Miele Dealer or
- The nearest Miele Service Department (see back cover for the address).

When contacting the Service Department, please quote the Model and Serial nos. of your appliance, both of which are shown on the dataplate visible above the sight glass on the inside of the door.

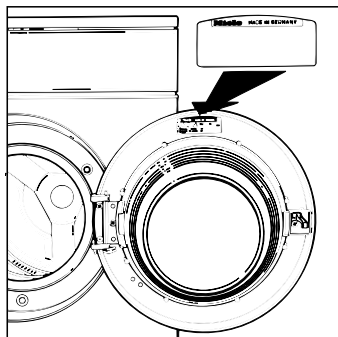

Example:



All modern detergents produced for automatic washing machines are suitable, including liquid, compact (concentrated) and special application detergents. Use dispensing aids e.g. balls if these are supplied with the detergent. Woollens and knitware containing wool mixtures should be washed using a detergent specifically designed for washing woollens.

Add the right amount of detergent as recommended on the packaging. The amount dispensed will depend on the following:

- the quantity of laundry
- the water hardness level
- the level of soiling

### It is important to dispense the correct amount, because...

...too little detergent results in the following:

- The laundry will not get properly clean and will in time become grey and hard to the touch.
- Greasy particles cling to the laundry.
- Lime deposits on the heater elements.

...too much detergent results in the following:

- Excessive foam.
- Low level of agitation.
- Poor washing and rinsing results.

Water is taken in through compartment **W** in the main wash. If the capacity of compartment **W** is insufficient for the amount of detergent needed where water hardness is above 380 mg/l (in hardness area 4), the Customer Service Engineer can adjust the machine so that water can also be taken in through compartment **U** to take detergent into the main wash.

### Water Softeners

A water softener can be used to cut down on the use of detergents in water hardness ranges 2 - 4. Dispense according to the amount specified on the packaging. First add detergent and then the water softener. Detergent can be dosed as for water hardness range 1.

We recommend: if you wash using several components (e.g. special application detergents), dispense the agents in the following order into compartment **W**:

1. Detergent
2. Water softener
3. Stain salts

This way the agents are distributed better.

## Installation surface

Experience has shown that a concrete floor is the most suitable for a washing machine. Concrete floors are far less prone to vibration during the spin cycle than wooden floorboards.

Please note the following points:

- The machine must be level and securely positioned.
- To avoid vibrations during spinning, the machine should not be installed on soft floor coverings.
- If installation must be on a wooden joist floor: we recommend the use of a plywood base (at least 59x52x3 cm). Ideally the base should be large enough to span several joists and should be bolted to the joists and not just the floorboards. Check for presence of pipes and cables first.
- As a general rule, we recommend the installation of the machine (or washer/dryer stack) in the corner of a room where the stability of the floor is at its greatest.
- If the machine is installed on a raised plinth, it **must** be secured against slippage during spin using retaining clips (available from the Miele Spare Parts Dept).

## Installation

Lift the machine from its packaging base and move it to its site. Please note:

- Do not lift the machine by the drum door.

- Ensure that the machine feet and the floor are dry to prevent the machine from slipping during the spin cycle.

## Removing the transit fitting.

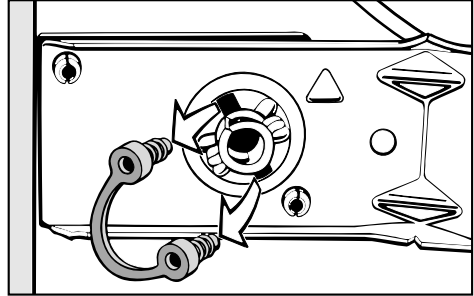

- Using combination pliers, pull out the retaining clips on the right and left of the support plate.

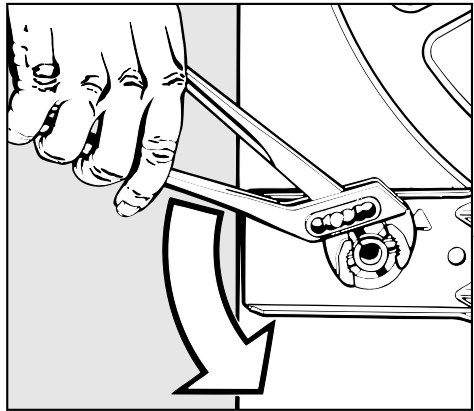

- Using a pipe wrench turn the left-hand transit bar 90° anti-clockwise and the right-hand transit bar clockwise.

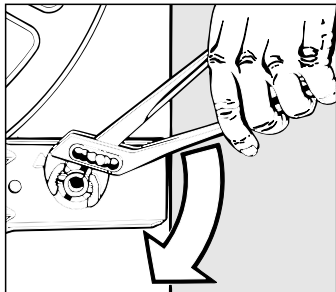

- Withdraw the two bars together with the support plate.

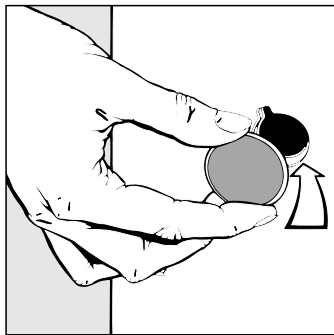

- Plug the two holes with the plastic caps supplied.

The machine should not be moved without the transit fitting in place.

The transit fitting should be stored in a safe place for future use. It must be re-fitted if the machine is to be moved again. Re-fitting is carried out by reversing the procedure.

### Washer-Dryer stack

A Miele tumble dryer can be stacked with this washing machine. A stacking kit\* can be purchased from the Miele Spare Parts Department.

All parts marked \* are available from the Miele Spare Parts or Sales Department.

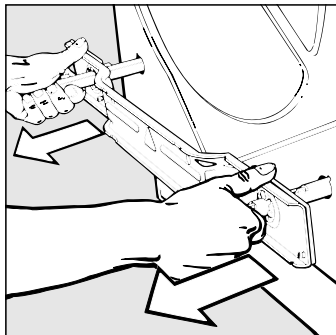

### Pre-treating the washing

Badly soiled areas, e.g. collars and cuffs, and water soluble stains, can be pre-treated with bar soap, liquid detergent or detergent mixed into a solution or paste.

With particularly stubborn stains ask your Dry Cleaner for advice.

Do not use detergents containing solvents in this machine.

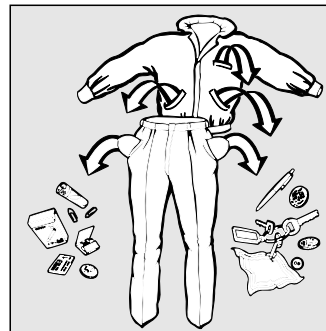

### Loading the drum

Unfold laundry and load loosely in the drum. To achieve best results it is advisable to make up mixed loads consisting of both large and small items. This improves the washing effect and helps distribute the load evenly to keep the machine stable and reduce the noise level during spinning.

It is advisable to weigh the load first to make best use of the machine's capacity.

- Empty all pockets.

Foreign objects (e.g. nails, coins, paper clips etc.) can cause damage to textiles and components in the machine.

### Sort the laundry

Most garments have a textile care label in the collar or side seam. Sort the laundry by care label symbols.

Only wash items in this machine which are declared by the manufacturer as being machine washable on the textile care label.

Dark textiles often contain "excess dye," and should be washed separately several times before being included in a mixed load.

Delicate textiles should be washed separately in a delicates programme.

Only wash textiles made from wool or wool mixtures if they are declared as being suitable for machine washing on the textile care label.

### Maximum load weights are noted below:

COTTONS . . . . .	5.0 kg
MINIMUM IRON . . . . .	2.5 kg
DELICATES/SYNTHETICS . . . . .	1.0 kg
WOOL . . . . .	1.0 kg
QUICK WASH . . . . .	2.5 kg

With curtains: Remove lead weights and strips or place in a laundry bag. Woollens and knitted garments should be turned inside out if the manufacturer recommends it.

### Close the drum door

Make sure that there is no obstruction between the drum door and seal.



## Levelling the machine

The machine must stand level to ensure smooth operation. Check with a spirit level.

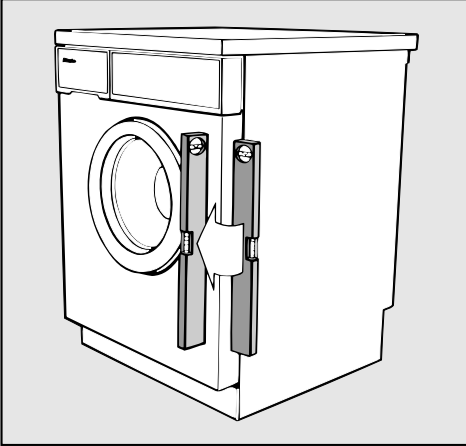

The feet are levelled using the leg levelers as follows:

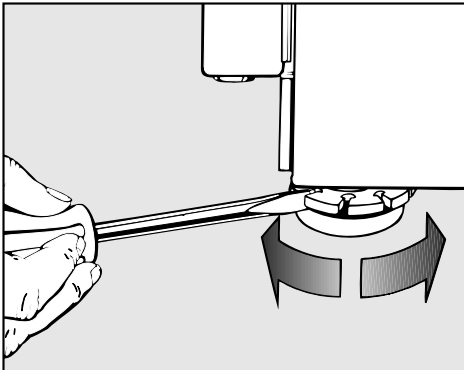

- Unscrew foot or feet until the machine stands level.
- Hold the foot tight using a pipe wrench.
- Tighten the counternut using a screwdriver as indicated.

## Building under

It is possible to install this appliance under a continuous worktop/in a kitchen run:

- A special building under kit \* is required.
- The machine lid must be replaced by a cover plate. This must be fitted by a suitably competent person exactly according to the fitting instructions included with the kit to ensure electrical safety.
- For installation under a work surface 900/910mm from the floor, a spacer kit \* is required.
- Connections for electricity, water and drainage should be installed in such a way that they remain accessible when the machine is in place.
- Fitting instructions are included with the kit.

All parts marked \* are available from the Miele Spare Parts or Sales Department.

## Electrical connection

### Electrical connection U.K.

This washing machine is supplied ready for connection to an a.c. single phase 230 V, 50 Hz supply. The rated load is 3.2 kW. The machine is supplied with a 2 m long mains cable with moulded plug and the fuse rating is 13A.

All electrical work should be carried out by a competent person, in accordance with national and local safety regulations.

Connection should be made via a fused plug and a suitable switched socket which is easily accessible.

For extra safety it is advisable to install a residual current device (RCD) with a trip current of 30 mA.

The voltage, rated load and fuse rating are given on the data plate. Please ensure that these match the household mains supply.

### Important

The wires in the mains lead are coloured in accordance with the following code:

Green/yellow = earth

Blue = neutral

Brown = live

As the colours of the wires in the mains lead of this appliance may not correspond with the coloured markings identifying the terminals in your plug, proceed as follows:

The wire which is coloured green and yellow must be connected to the terminal in the plug which is marked with the letter E or by the earth symbol  $\perp$  or coloured green or green and yellow.

The wire which is coloured blue must be connected to the terminal which is marked with the letter N or coloured black.

The wire which is coloured brown must be connected to the terminal which is marked with the letter L or coloured red.

### WARNING

### THIS APPLIANCE MUST BE EARTHED.

## Warning and Safety Instructions

This appliance is designed and intended only for normal household use in the U.K. It should never be operated by children. Supervise its use by the elderly or infirm.

Read the operating instructions through before using this machine for the first time, as this is for your safety and the protection of the machine. They give notes on the safety, the use and the maintenance of the machine.

Further warning and safety instructions are given in the text as appropriate.

### ...before using for the first time

Do not install your washing machine in rooms where sub-zero temperatures may occur. Frozen hoses may burst under pressure.

The reliability of the electronic control system may be impaired at temperatures below freezing point.

Before using the machine for the first time, check that the transit fitting at the rear of the machine has been removed (see page 31). During spinning, a transit fitting which is still in position may result in damage to both the machine and adjacent furniture or appliances.

If the drain hose is attached to a wash basin or sink, make sure it is secure, (see illustration in the section "Guide to the machine"), so that the force of the water flowing out of the hose does not dislodge it, as this will otherwise result in flooding. If hooking the hose into a wash basin, check that the water can drain off

quickly enough to prevent the sink from overflowing.

Keep these operating instructions in a safe place.

### ...when using your machine

Only wash items which are declared by the manufacturer to be machine-washable on the care label (textile care G.B. laundry care, AUS), (see Care labels on page 10).

Descaling agents contain acid. Only use proprietary non-corrosive descaling agents and strictly observe the manufacturer's instructions. After descaling, always run several full rinse cycles to remove any acid residue and to protect component parts from corrosion.

Never use detergents containing solvents in this machine, as this may result in damage to component parts and create toxic fumes. Such detergents also pose a fire and explosion hazard.

Textiles which have been pre-treated in detergents containing solvents must be thoroughly rinsed in clean water before being washed in this machine.

Do not use dye removers as these contain sulphur compounds which may damage washing machines.

# Electrical connection

---

Non-rewireable plugs BS 1363

If this machine or appliance is fitted with a non-rewireable plug, the following information applies:

If the socket outlets are not suitable for the plug supplied with this product, it must be cut off and an appropriate plug fitted.

The plug cut from the flexible cord should be disposed of and on no account be inserted into a 13 A socket elsewhere in the house (electric shock hazard).

The fuse cover must be refitted when changing the fuse, and if the fuse cover is lost, the plug must not be used until a suitable replacement is obtained. The colour of the correct replacement cover is that of the coloured insert in the base of the plug, or the colour that is embossed in words in the base of the plug (as applicable to the design of plug fitted).

The correct fuse rating of the replacement fuses that are ASTA approved to BS 1362 should be fitted. Replacement fuse covers may be purchased from your local electrical suppliers, electricity showroom, or Miele Service Agent.

(The German standard version is supplied with a 2 m long cable and moulded plug for connection to a 220/230 V single phase supply. It must only be connected via a fused 16 A socket. See data plate for rated load. Electrical installation should be approved by a qualified electrician).

### Connection to water supply

The machine should be connected to a mains water supply in accordance with standard regulations. The German authorities do not require it to have a non-return valve as the washing machine has been designed to comply with DVGW regulations (German Association of Gas and Water Engineers, see data plate).

Connection to a mains water supply should be carried out by a qualified plumber and should incorporate a mains stopcock with 3/4" thread

The 1.5 m long 3/8" pressure hose should be connected to the stopcock via the 3/4" threaded union.

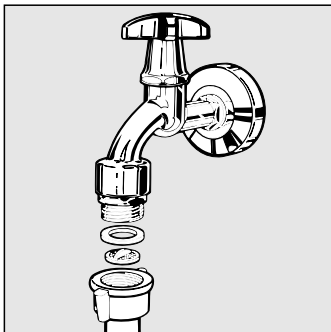

This hose is **not** suitable for use for connection to a hot water supply. Please make sure that the washer sits correctly in the union.

If connection is to be made to a stopcock with a short 3/4" thread, the extra washers enclosed should also be inserted in the inlet hose union to compensate.

The connection points are subject to mains water pressure. Turn on the stopcock slowly and check for leaks. Correct the positioning of the washers and screw unions if appropriate.

If replacing the inlet hose only use a hose able to withstand pressure of up to 70 bar. This also applies to all fittings used. Miele original parts fulfil this condition.

Longer hoses 2.5 or 4.0 m in length are available as optional extras.

The pressure hose and solenoid inlet valve are designed for a water flow-pressures of between 1 and 10 bar (981 kilonewtons/m<sup>2</sup>). At higher water pressures it is essential to fit a reducer valve.

There is a minimum flow pressure of 1 bar pressure if 5 litres of water flow into a suitable container in 15 seconds.

The two dirt filters, one at the inlet point, one in the pressure hose union, must not be removed.

### Caring for the environment

Caring for the environment means saving water, energy and detergent when washing. This machine is equipped with the Hydromatic System and the Ball Valve for economical use of resources. These systems offer a variety of technical innovations e.g. the drum ribs, which are designed to enable economical washing without compromising on results.

The automatic load control facility enables loads of between 1 and 5 kg to be washed using only as much water and electricity as is required for an effective wash.

Spinning at the high speed of 1200 rpm reduces drying times and energy consumption if laundry is dried in a tumble dryer after washing.

### Economy tips

To help you wash most economically, remember the following tips:

- Always wash with the maximum laundry load specified for each programme. This uses the energy to the best advantage.
- Only use the correct amount of detergent required for the water hardness level in your area, as recommended by the manufacturer.
- If laundry is not heavily stained, select a lower temperature setting than indicated on the laundry care label (but when using a lower temperature do not select the "short"-option).
- Lightly soiled laundry can be washed using a "short"-programme (additional temperature reduction not recommended).

## Connection to drainage

The machine drains via a drain pump with a delivery head of one metre. The hose must not be kinked as this restricts drainage. The hooked piece at the end of the hose can be turned in either direction.

## Hose dimensions:

Length . . . . .	- 1.5 m
Internal diameter . . . . .	- 22 mm
External diameter . . . . .	- 30 mm
External diameter of hooked end . . . . .	- 32 mm

## The drain hose may be connected as follows:

- Direct into a sink: Hook the hose over the edge and secure.  
Make sure that the water can flow away freely to avoid flooding and to prevent water from being sucked back into the machine.
- Connected to a plastic drain pipe with a rubber nipple. There is no need to use a non-return valve.
- Directed into a standpipe.
- Allowing the water to drain off into a floor drain.

If required, the hose can be extended to a length of 5 m.

For a delivery head of more than 1 m up to a maximum of 1.80 m, a second Duo drain pump is available with the corresponding conversion kit from the Miele Spare Parts Department.

## Technical data

Height .....	85 cm
Width .....	59.5 cm
Depth .....	60 cm
Depth with door open .....	97 cm
Weight .....	95 kg
Max. floor load .....	1600 Newton (approx. 160 kg)
Capacity .....	5 kg dry laundry
Connected load .....	} see data plate
Rated load .....	
Fuse rating .....	
Water flow pressure min. ....	1 bar
Static water pressure max. ....	10 bar
Maximum delivery head .....	1 m
Maximum length for drainage pump ..	5 m
Consumption data (DIN EN 60456)	
Cottons 60°C .....	Electricity: 1.1 kWh Water: 63 litres
Test certificates awarded .....	Radio/tv suppression, VDE
Electrically suppressed according to ..	DIN EN 60555/VDE 0838

## Guide to the machine

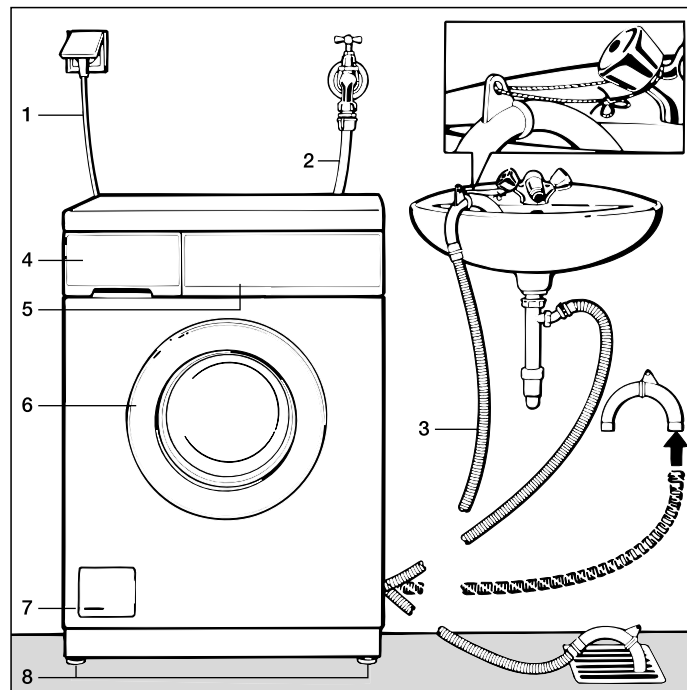

- |  |  |
|--|--|
| <b>1</b> Supply cable  | <b>6</b> Drum door   |
| <b>2</b> Inlet hose (able to withstand pressures up to 70 bar) | <b>7</b> Access panel - drain pump and filter, emergency door opener |
| <b>3</b> Flexible drain hose, with detachable swivel elbow     | <b>8</b> Four height adjustable feet                                 |
| <b>4</b> Detergent dispenser drawer                            |  |
| <b>5</b> Facia panel with controls                             |  |



# Miele

United Kingdom

Miele Co. Ltd., Fairacres, Marcham Road, Abingdon, Oxon, OX14 1TW

tel. Abingdon (01235) 554455 - fax (01235) 554477

Service Office, tel. Abingdon (01235) 554466